

BREVET DE TECHNICIEN SUPÉRIEUR

INDUSTRIALISATION DES PRODUITS MÉCANIQUES





E4 : ÉTUDE DE PRÉINDUSTRIALISATION

DOSSIER RÉPONSE

Contenu du dossier : 19 documents dont 4 formats A3

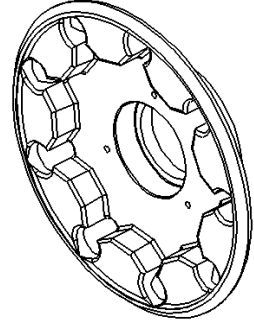
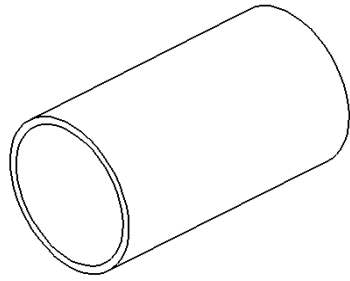
3 Problématique : Comment identifier les surfaces fonctionnelles du flasque ?

3.1

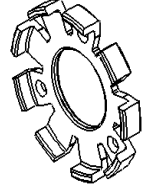
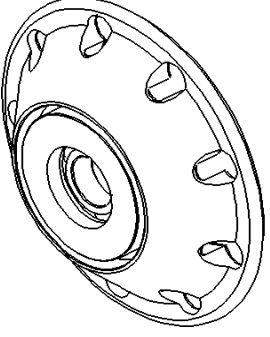
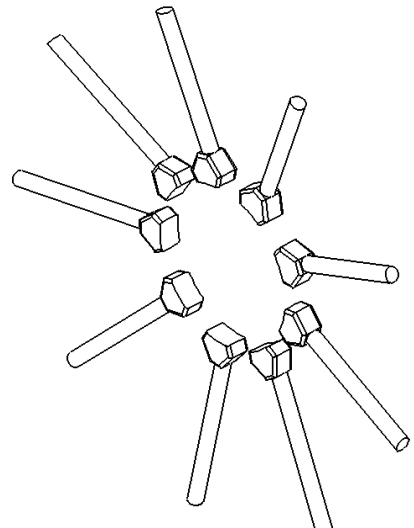
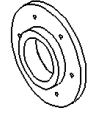
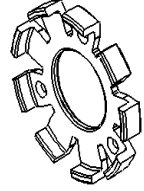
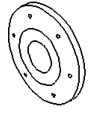
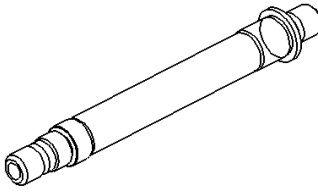
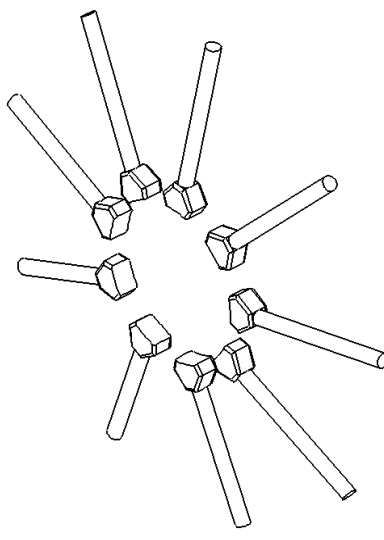
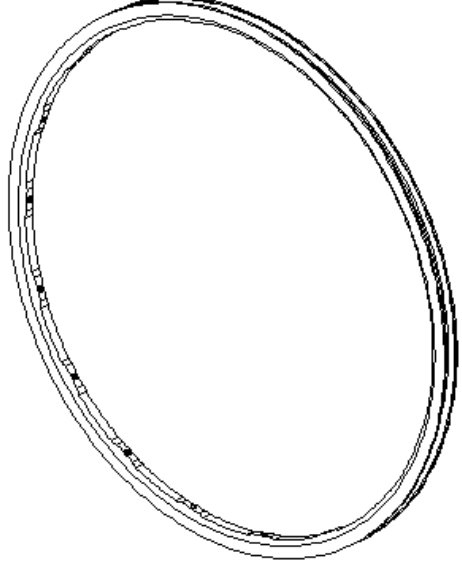
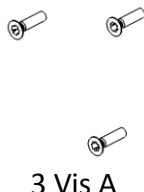
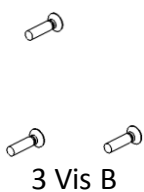
 Roulement 1	 Flasque 1	 Fût en carbone	 Contre écrou 1
 Roulement 2			 Contre écrou 2
 Bague de rayon 1	 Flasque 2	 9 Rayons et têtes 2	 Coupelle taraudée
 Bague de rayon 2			 Coupelle lisse
 Axe	 9 Rayons et têtes 1	 Jante	
 3 Vis A			
 3 Vis B			

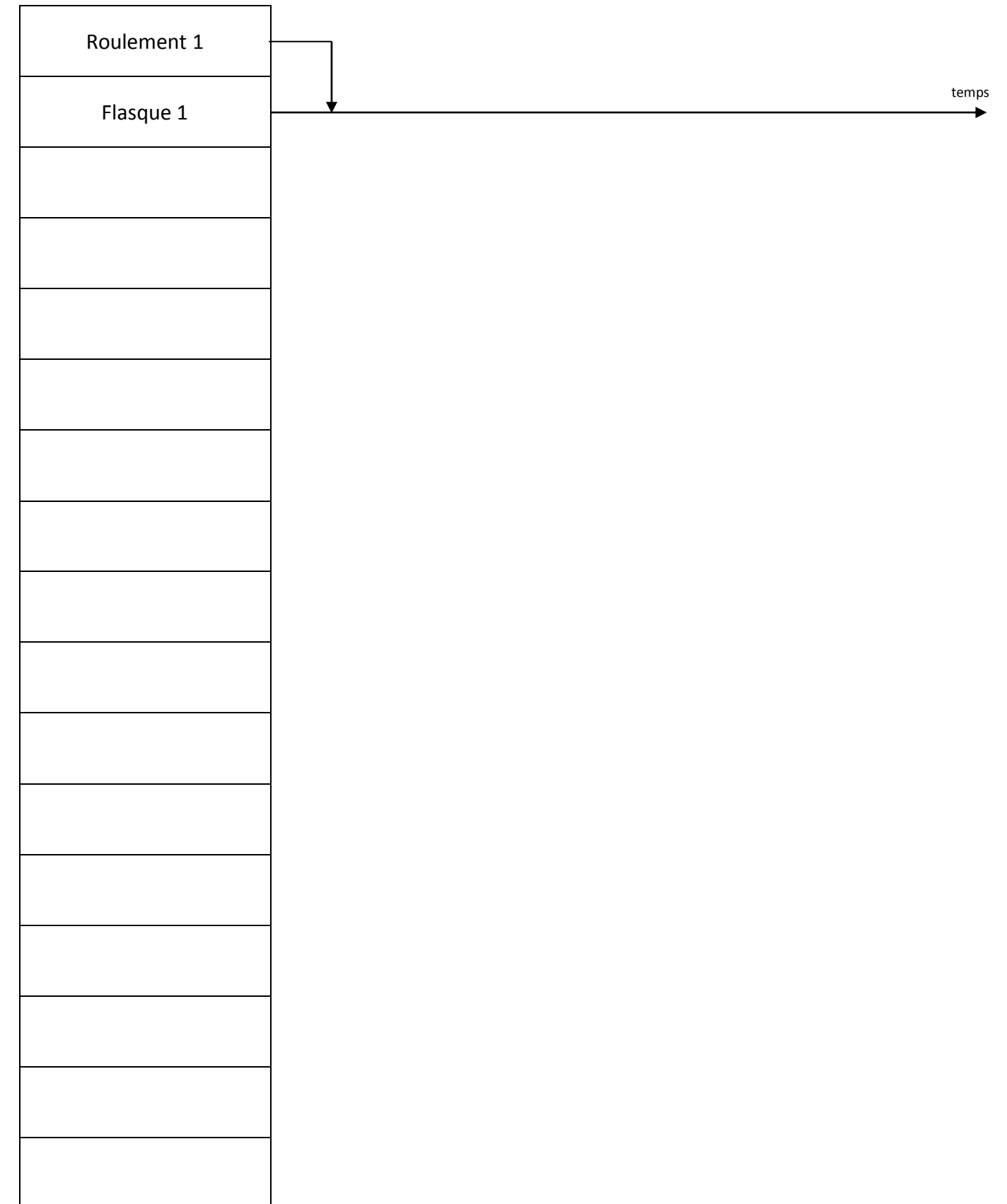

3.2

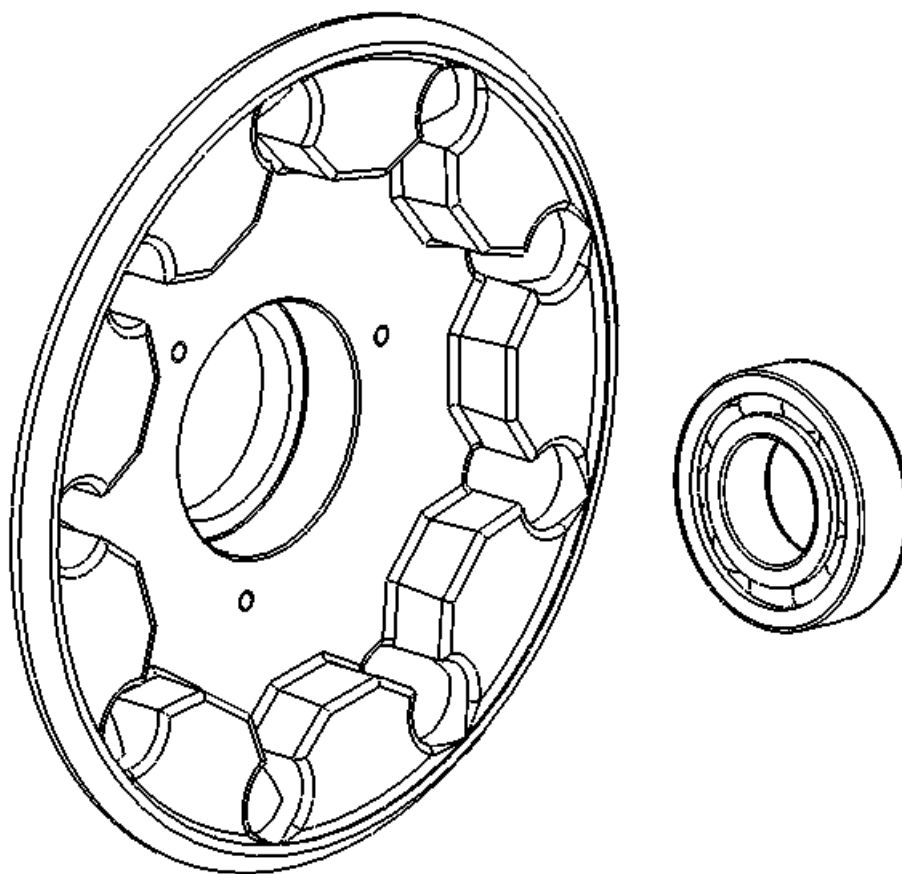

3.3

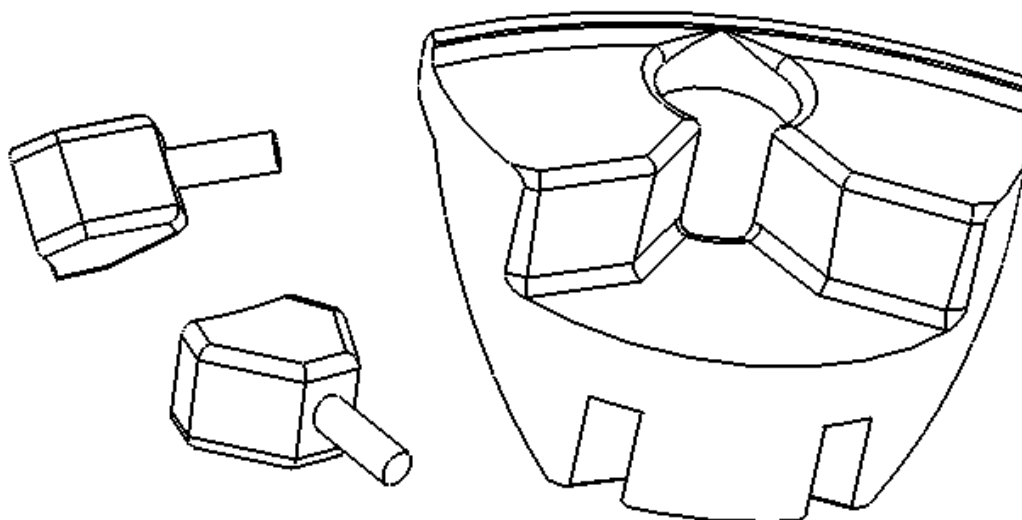

3.4

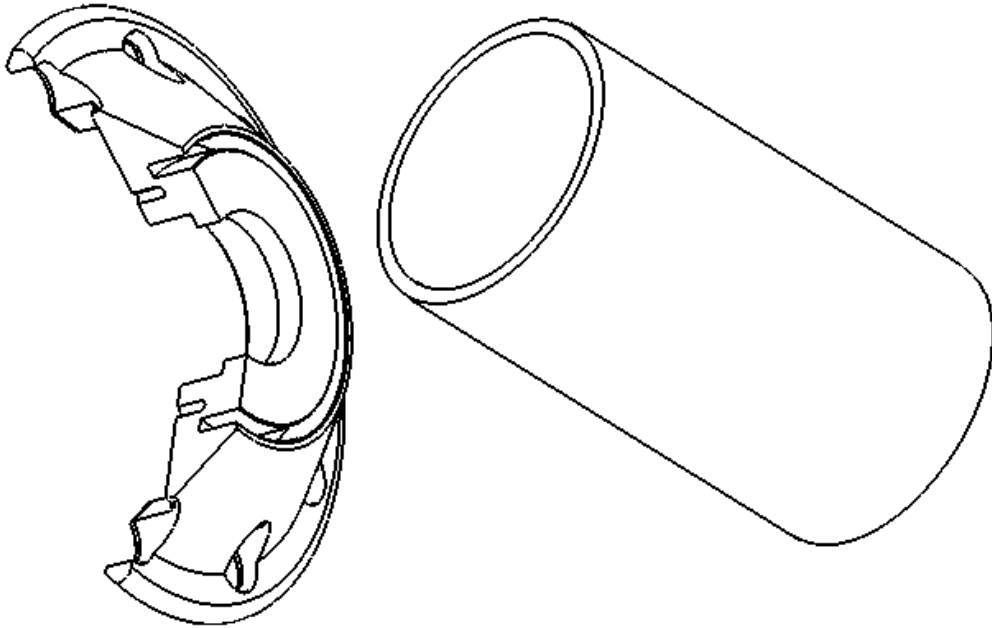

4 Problématique : Quels sont les procédés qui permettront de réaliser le flasque ?

4.1

4.2

4.3

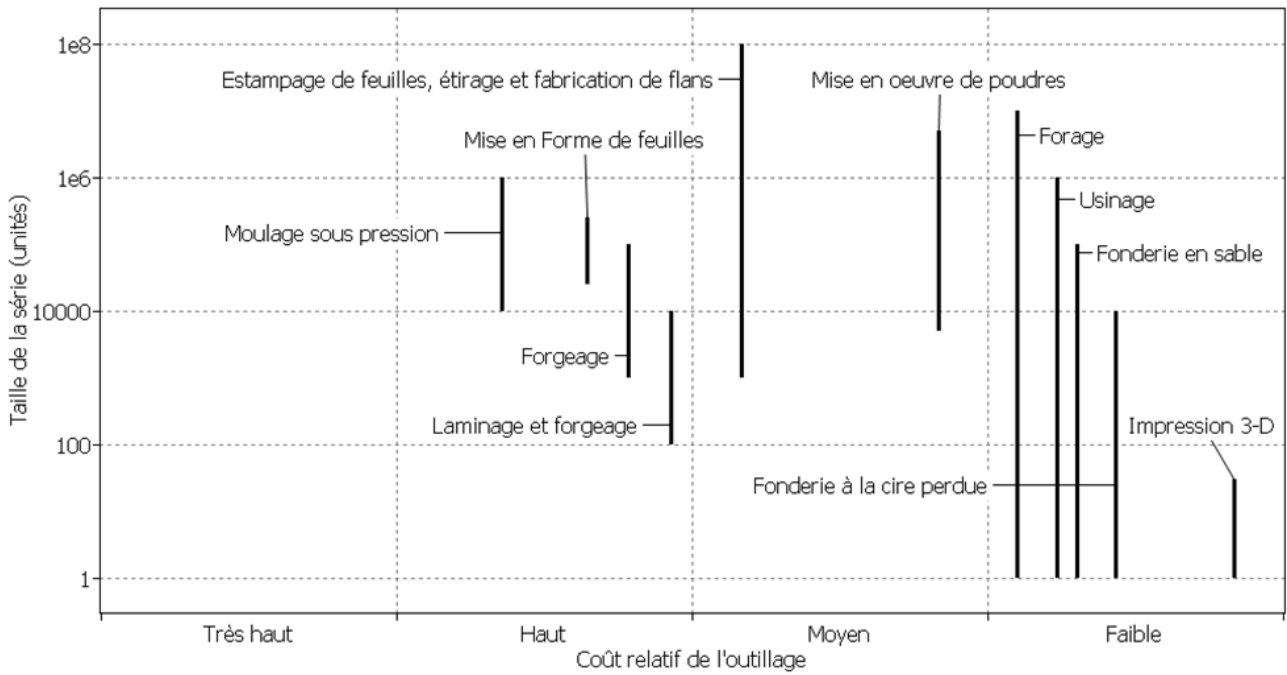
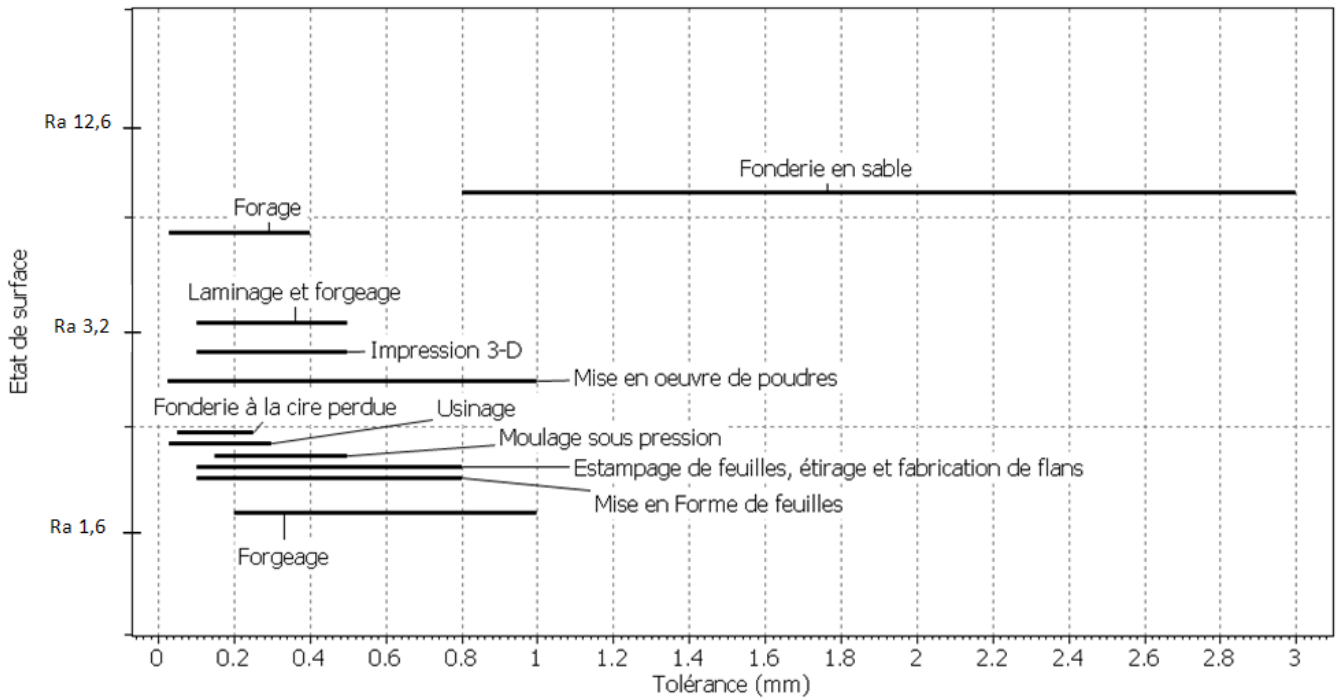

4.4



5 Problématique : Est-il possible d'obtenir un brut du flasque en moulage ?

- 5.1
- 5.2
- 5.3

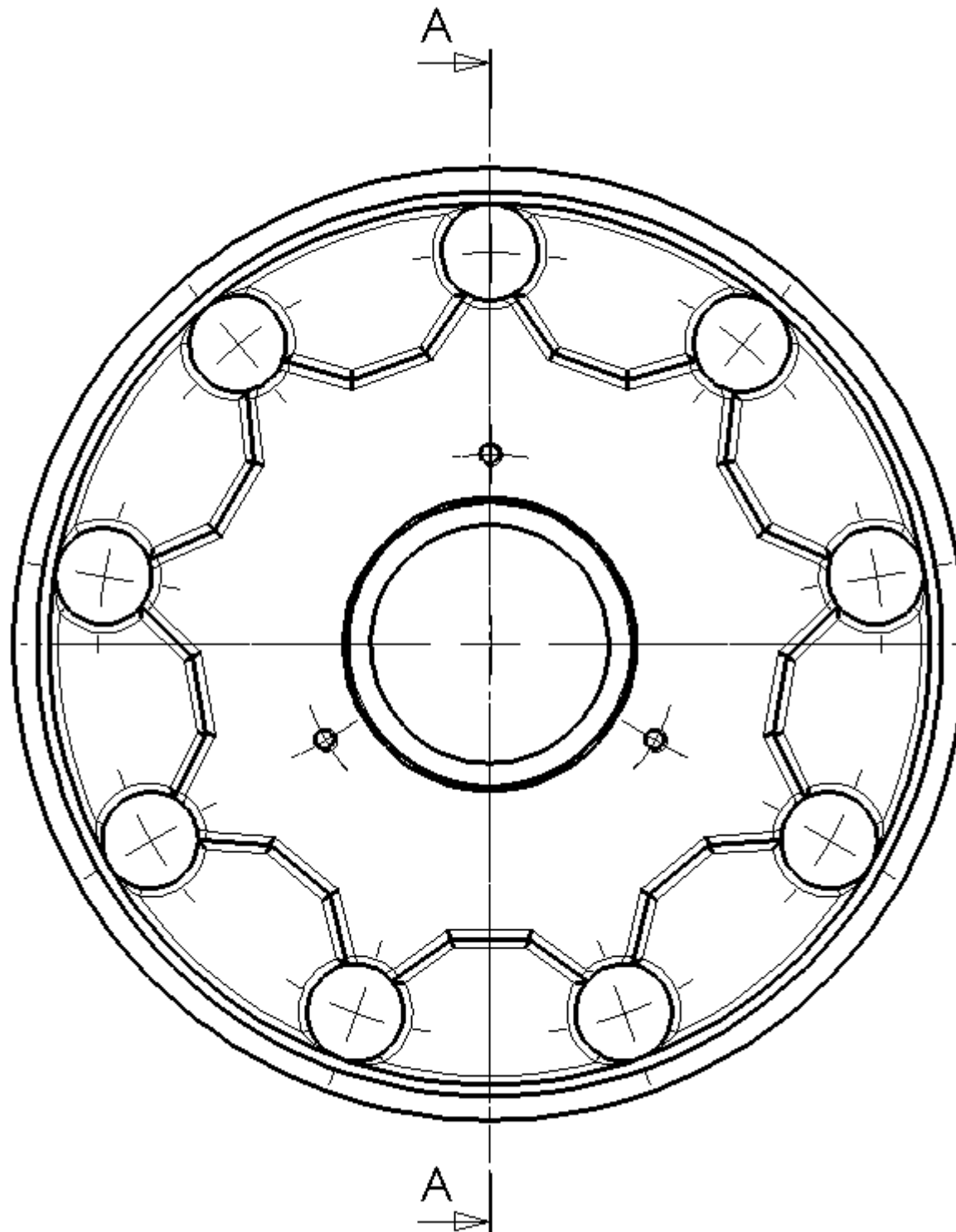

SECTION A-A

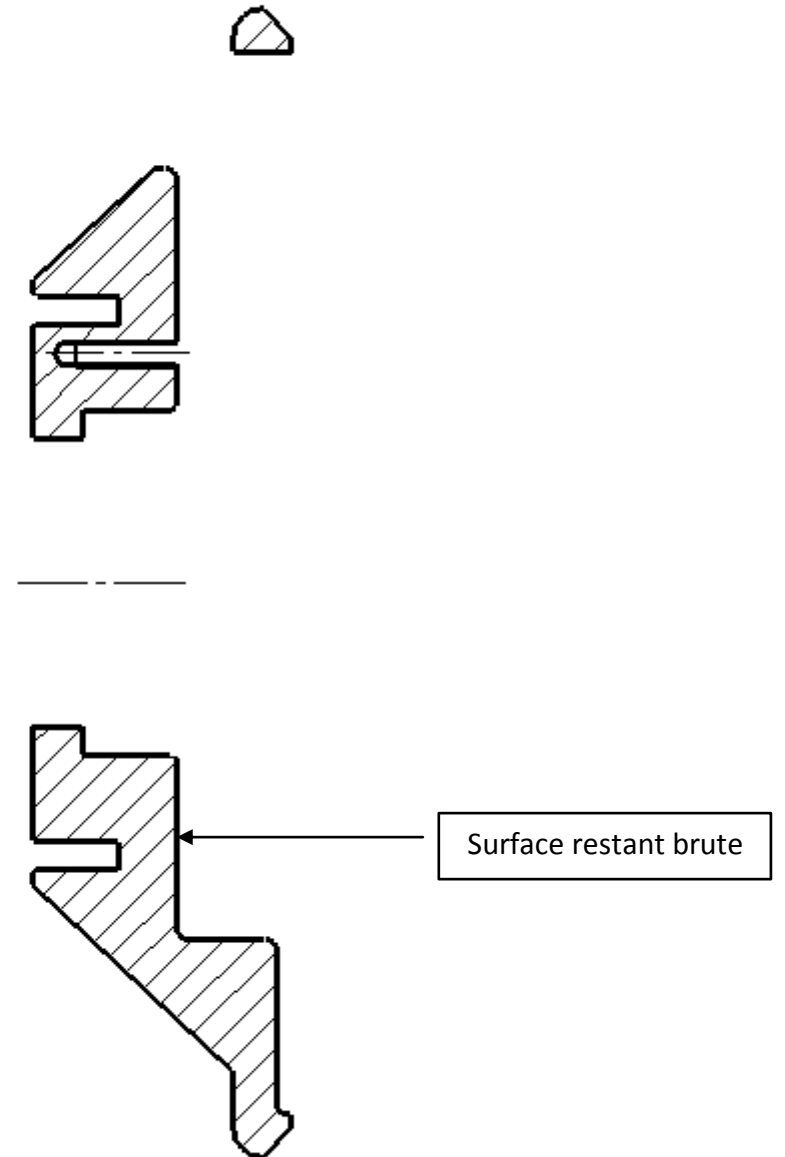

5.4

6 Problématique : Quel procédé choisir d'un point de vue économique ?

6.1

Procédés	Investissement préalable	Prix de revient par pièce Usinage et prix matière
Moulage en cire perdue		
Usinage dans la masse	0	

6.2

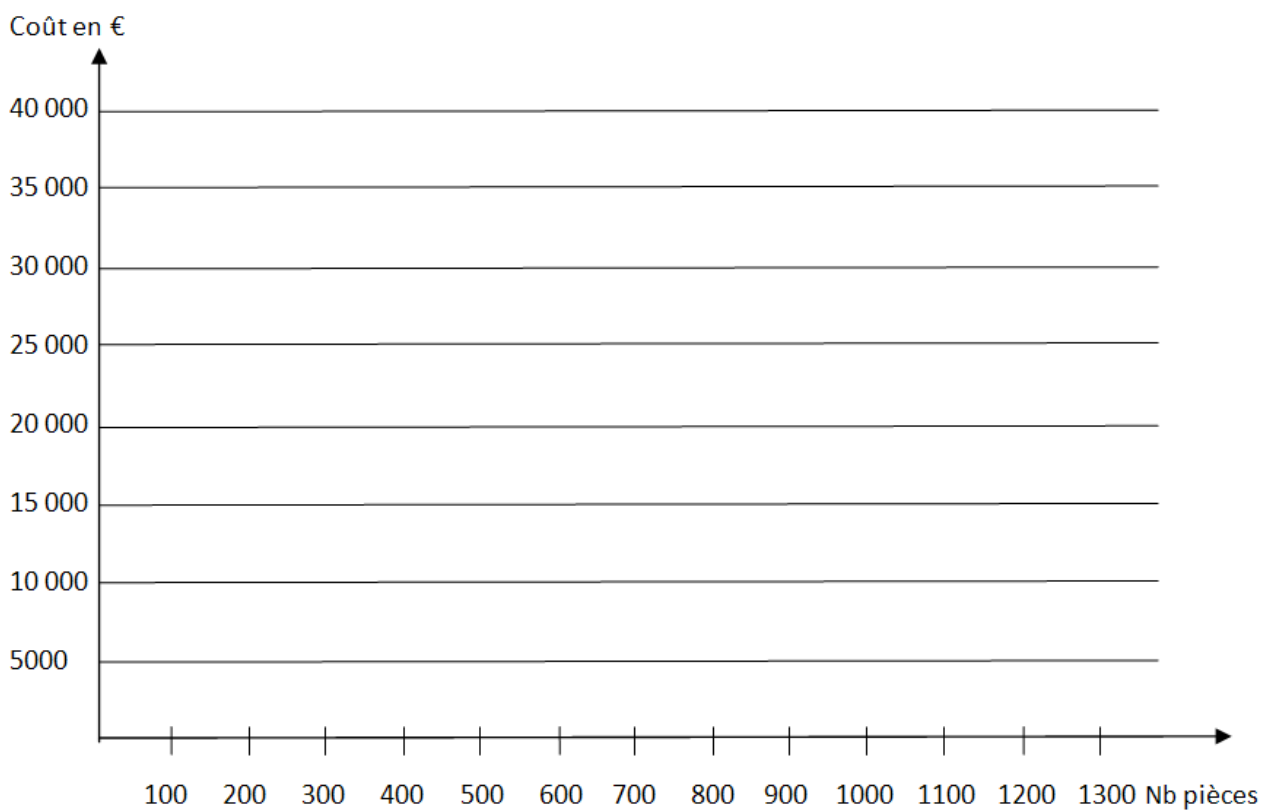

6.3

De 0 à _____ pièces	Procédé :
Pour + de _____ pièces	Procédé :

7 Problématique : Faut-il prendre des précautions lors de l'usinage du Zicral ?

La composition chimique du ZICRAL en % est la suivante : Al Zn6 Mg Cu

7.1

<u>Mg</u> : 2.1% à 2.9%	<u>Zn</u> : 5.1% à 6.1%	<u>Al</u> : Le reste
Ti : Titane 0.20% maxi	Cr : Chrome 0.18 à 0.28%	Mn : Manganèse 0.3 maxi%
Si : Silicium 0.4% maxi	Fe : Fer 0.5% maxi	Cu : Cuivre 1.2% à 2.0%

7.2

7.3

8 Problématique : Comment s'assurer que les roulements seront convenablement positionnés sur le poste d'assemblage ?

8.1

Calculs :

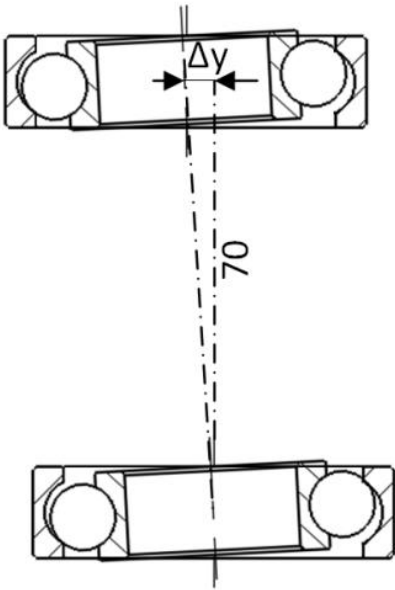
 $\Delta y =$ mm

Compatibilité : _____

8.2

Calculs :

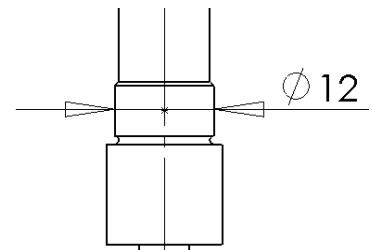

Dmaxi =

Dmini =

8.3

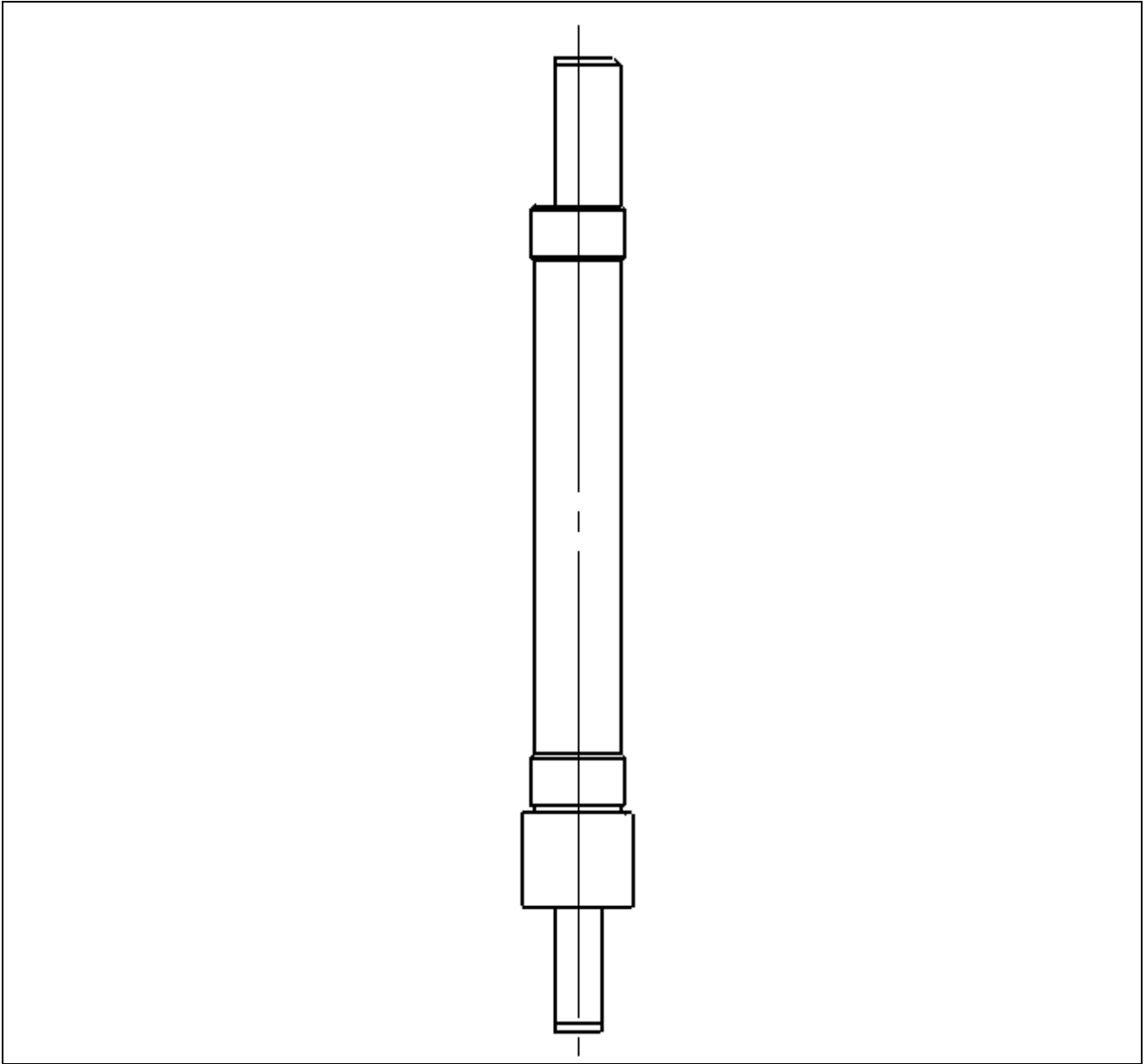

8.4

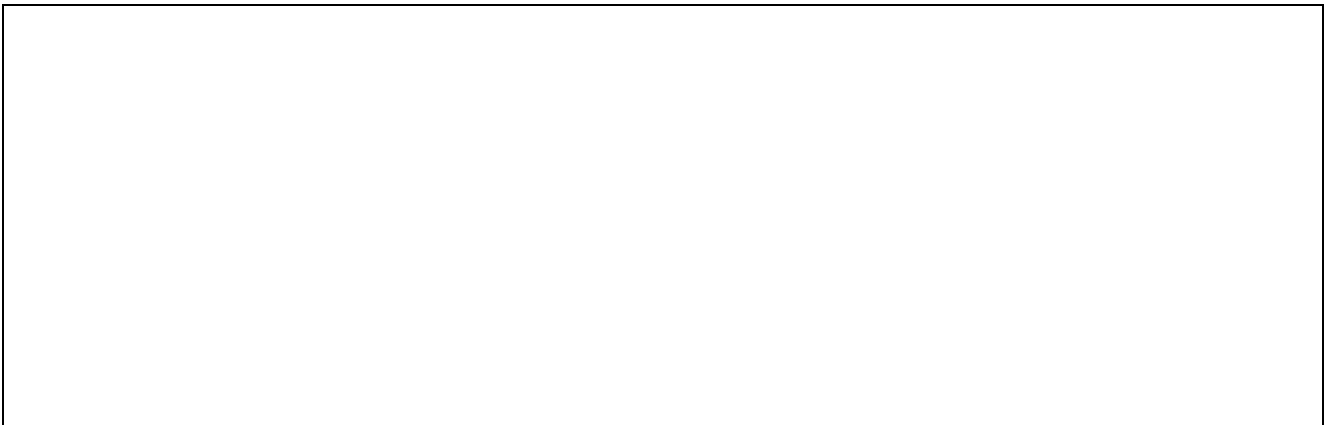

9 Problématique : Comment simplifier la liaison entre le flasque et le fût en carbone ?

9.1

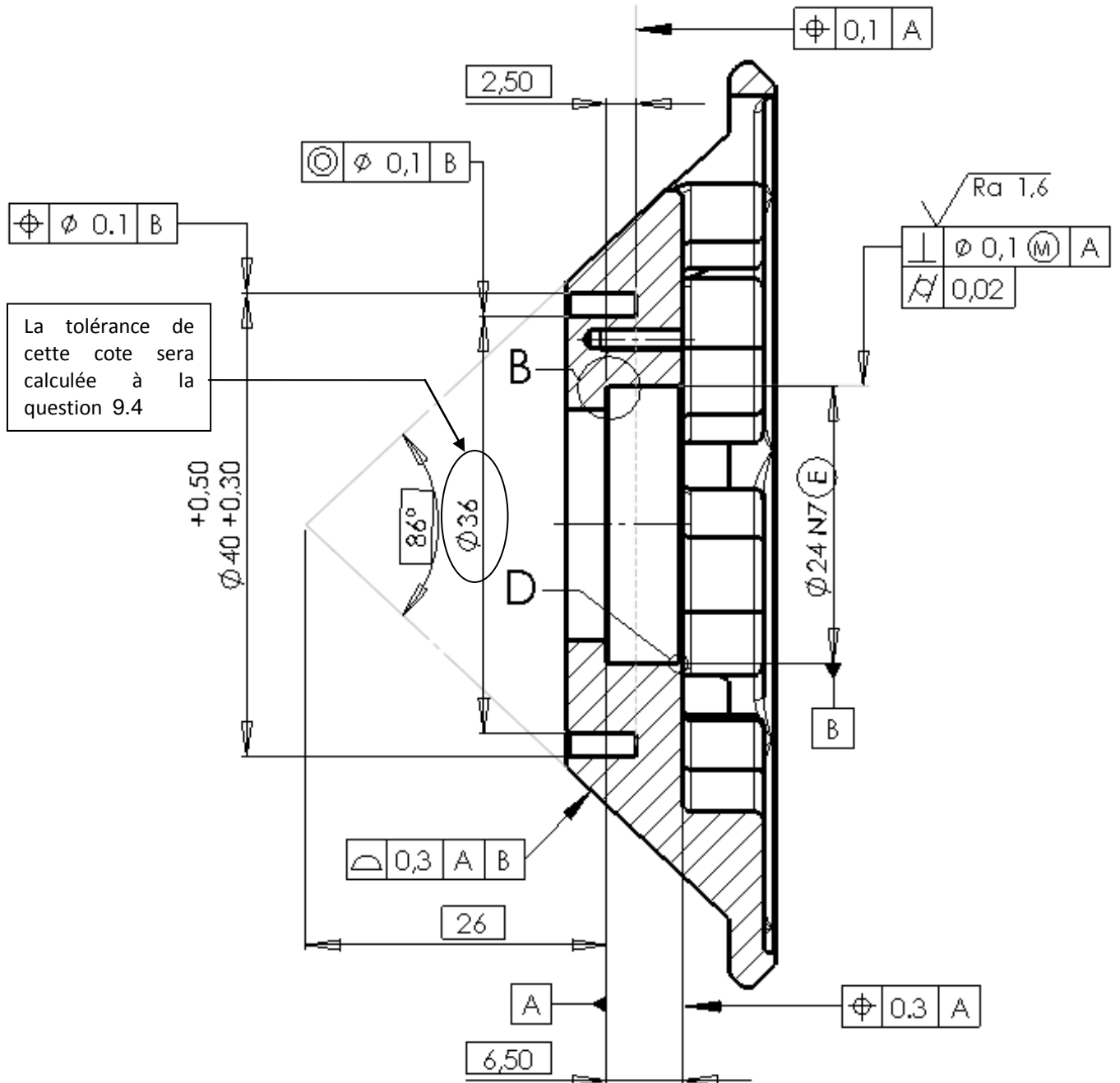

9.2

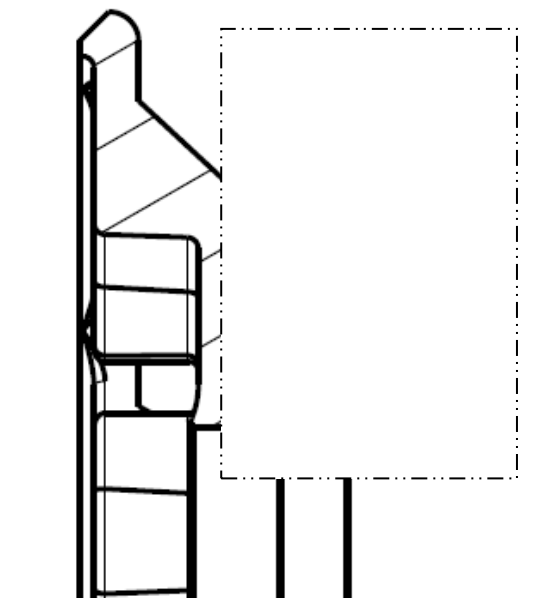

9.3

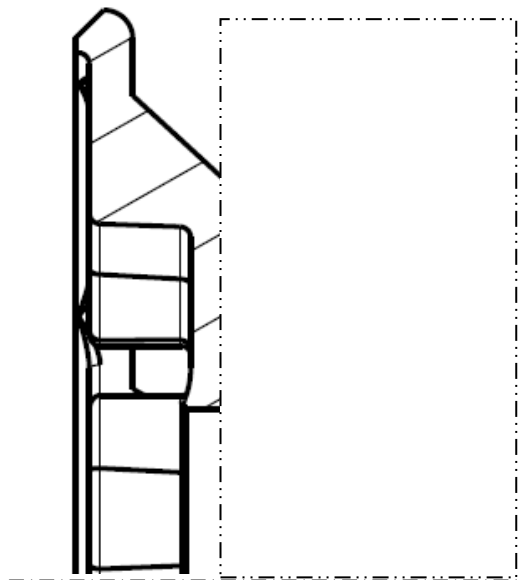

Echelle 2 :1

9.4

Détail du calcul



10 Problématique : Comment améliorer la fabrication de la portée de roulement dans le flasque ?

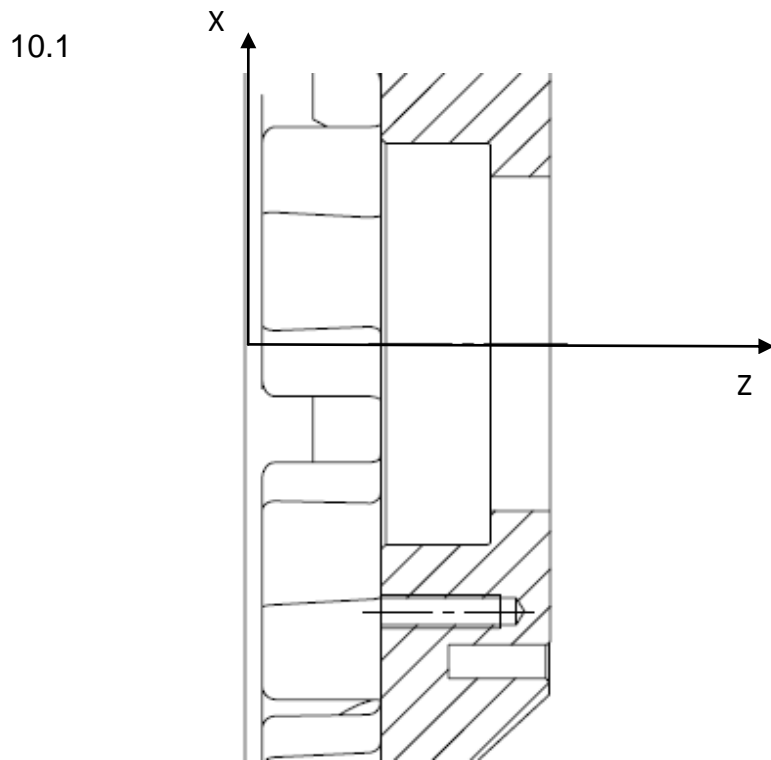

10.2

Dessin Plaquette :

Rayon maximum :

11 Problématique : Comment réaliser les surfaces permettant la liaison entre le flasque et les têtes de rayons ?

11.1

Complétez le tableau ci-dessous

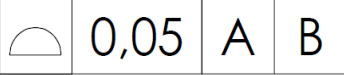
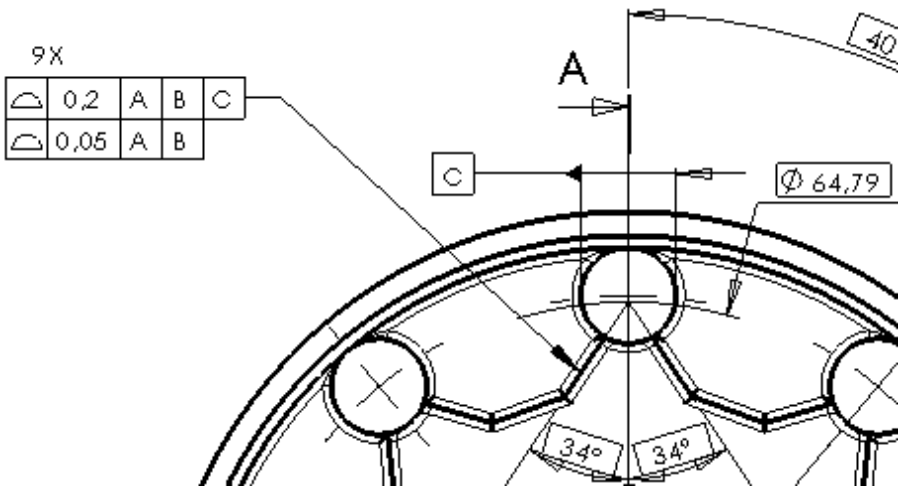
TOLERANCEMENT NORMALISE	Analyse d'une spécification par zone de tolérance				
	Eléments non idéaux		Eléments idéaux		
Type de spécification Forme Orientation Position Battement	Elément(s) tolérancé(s)	Elément(s) de référence	Référence(s) spécifiées(s)	Zone de tolérance	
Condition de conformité L'élément tolérancé doit se situer tout entier dans la zone de tolérance.	<input type="checkbox"/> unique <input type="checkbox"/> groupe	<input type="checkbox"/> unique <input type="checkbox"/> multiple	<input type="checkbox"/> simple <input type="checkbox"/> commune <input type="checkbox"/> système	<input type="checkbox"/> simple <input type="checkbox"/> composée	Contraintes Orientation par rapport à la référence spécifiée
Spécification Extrait du dessin de définition 					

11.2

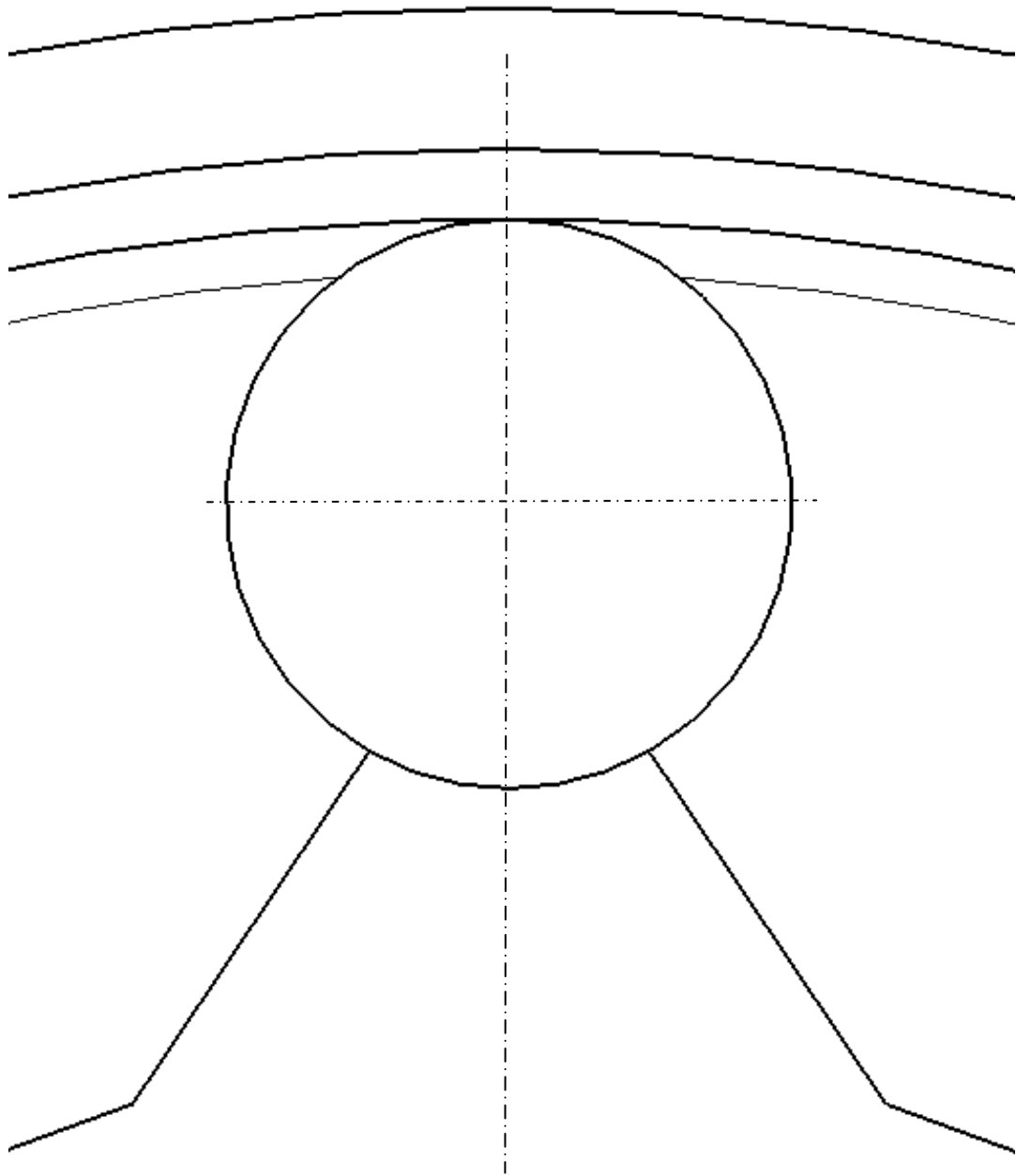

Echelle 10 : 1

11.3

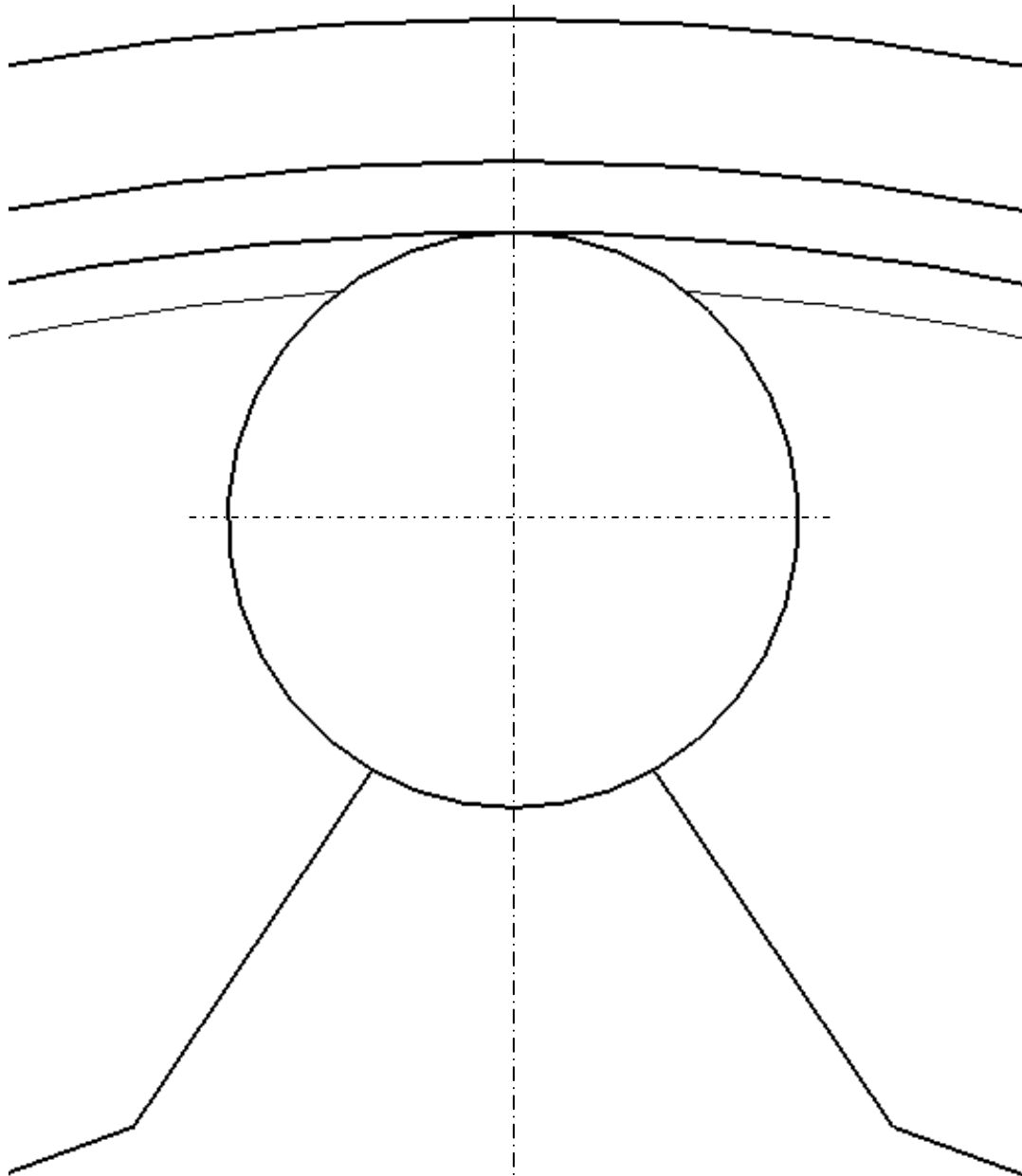

Echelle 10 : 1

12 Problématique : La modification de la forme du flasque est-elle techniquement envisageable ?

12.1

12.2

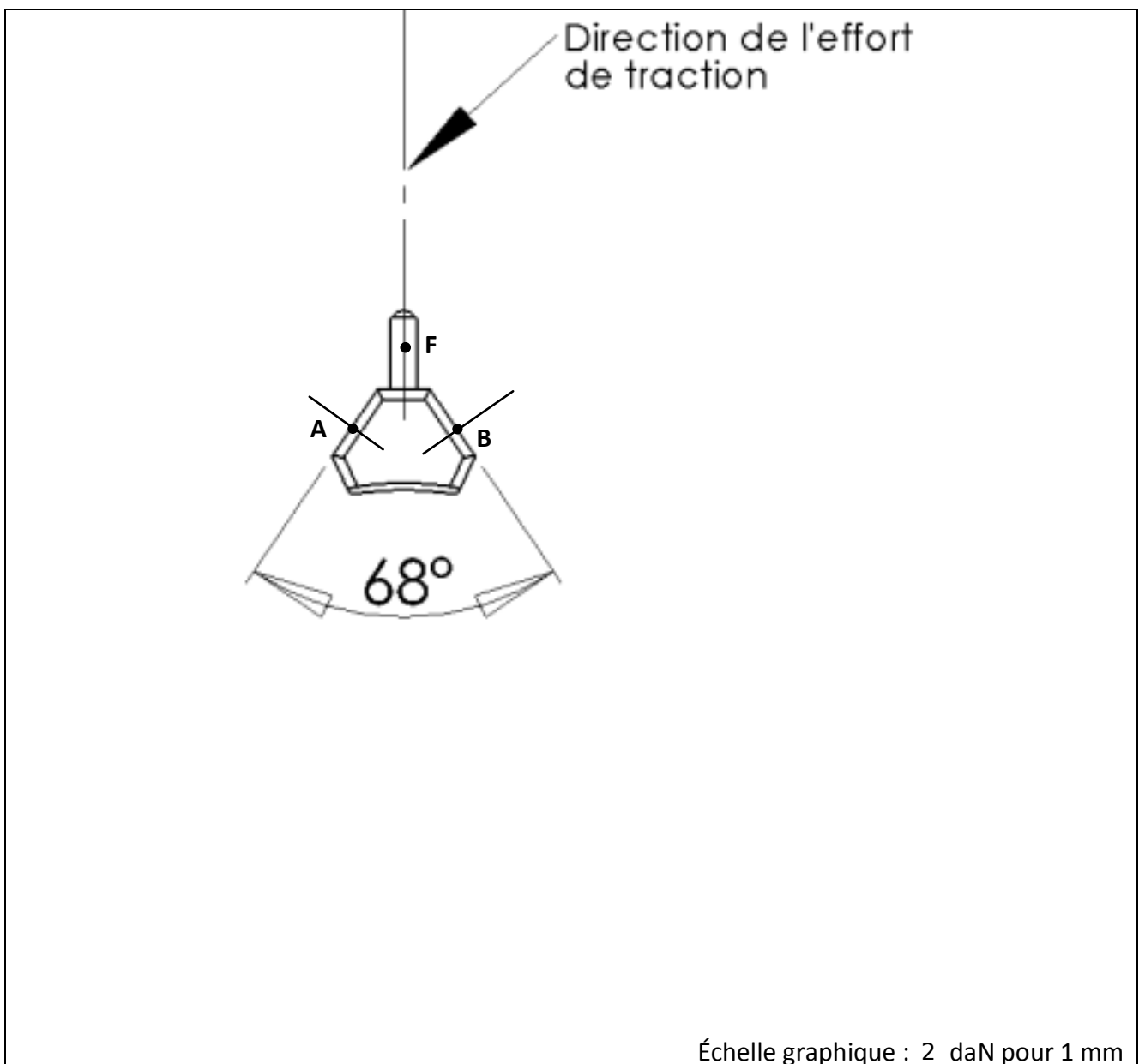

12.3

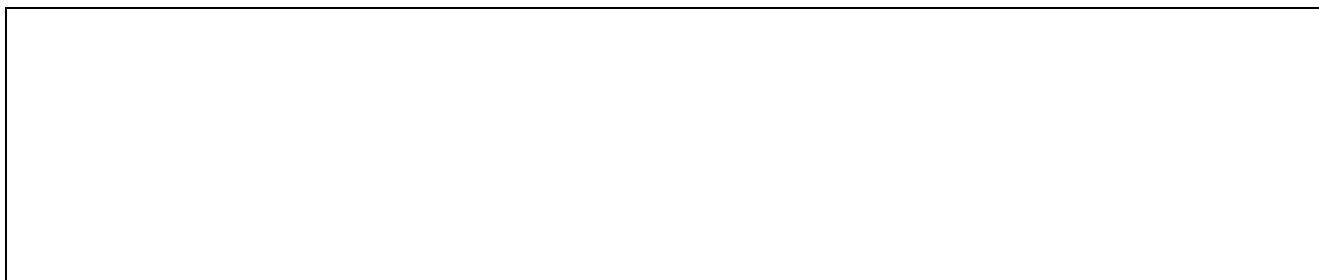

12.4

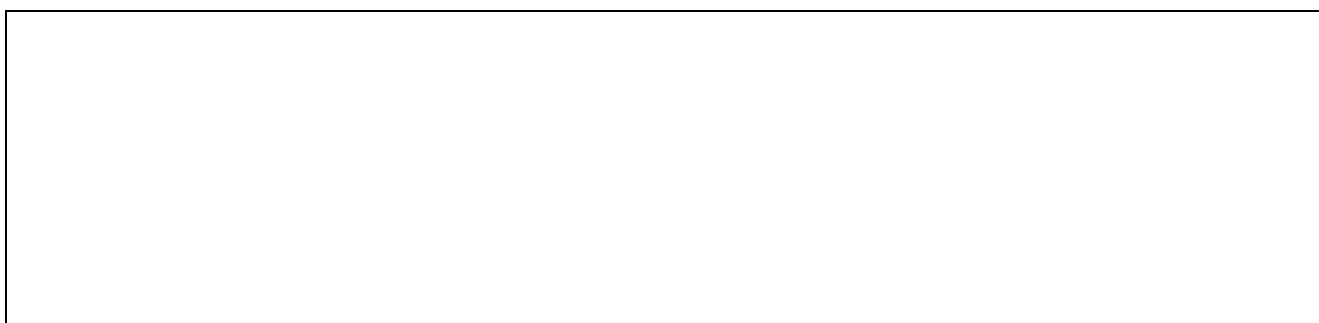

12.5

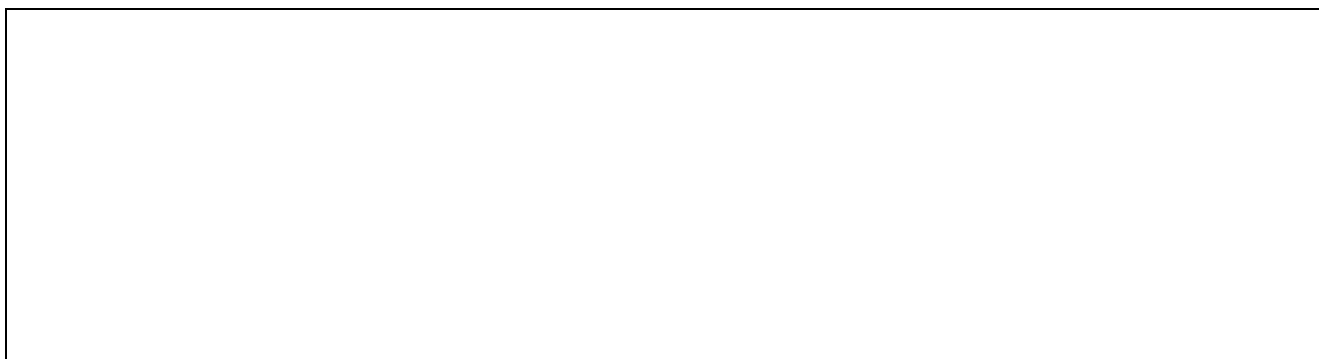

13 Problématique : Comment orienter le flasque sur la palette Erowa ?

13.1

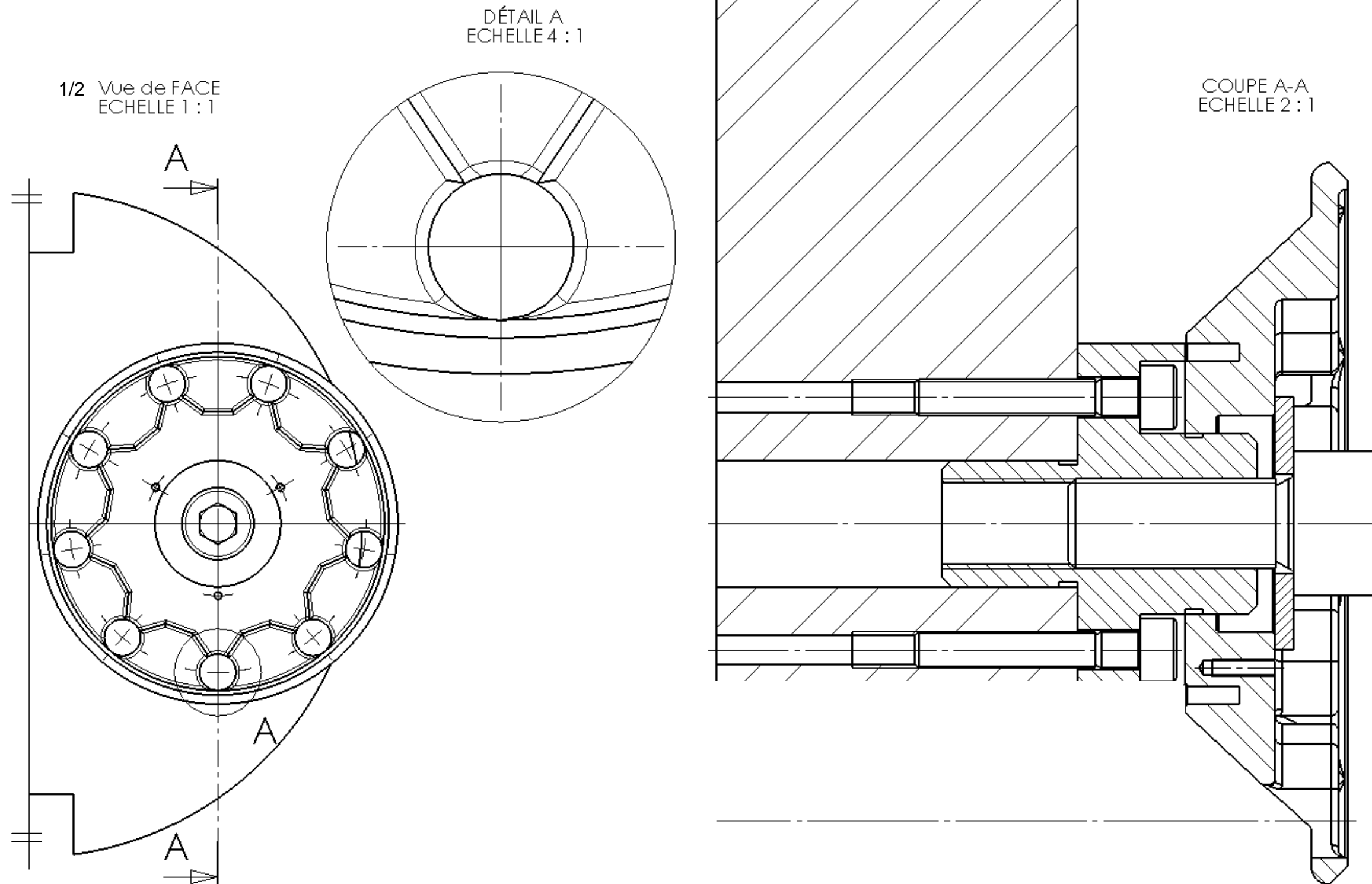

13.2

Echelle 1 :1

